

# ECOPHON SUPER G™ A

Ecophon Super G™ A has an exposed grid system with impact bracing bars or clips to keep tiles in place. For applications in school corridors and other environments where there is a risk for mechanical impact.

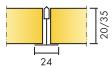

# Ecophon Super G™ A



## SYSTEM RANGE

| Size, mm        | 600x600 | 600x600 | 1200x600 | 1200x600 |
|-----------------|---------|---------|----------|----------|
| T24             | •       | •       | •        | •        |
| Thickness (THK) | 20      | 35      | 20       | 35       |
| Inst. Diagr.    | M199    | M55     | M199     | M55      |

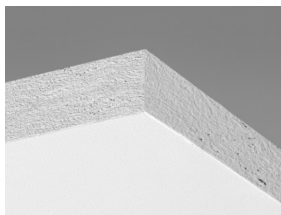

Super G tile

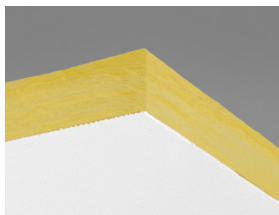

Super G A tile

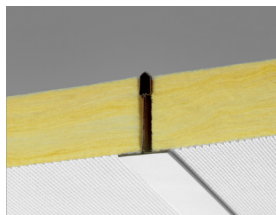

Section of Super G A system with Connect T24



Super G A system

## TYPE OF APPLICATION

- Additional areas
- Education



## ACOUSTICS

### Sound Absorption

Test results according to EN ISO 354. Classification according to EN ISO 11654, and the single value ratings for Noise Reduction Coefficient, NRC and Sound Absorption Average, SAA according to ASTM C 423.

$\alpha_p$ , Practical sound absorption coefficient

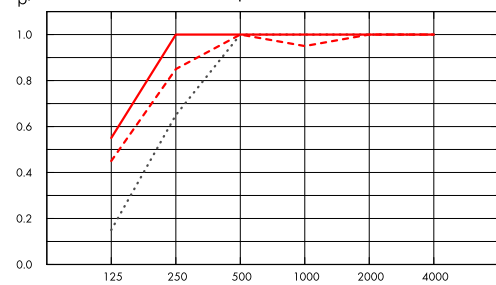

--- Super G A 20 mm, 200 mm o.d.s.

.... Super G A 35 mm, 50 mm o.d.s.

— Super G A 35 mm, 200 mm o.d.s.

o.d.s = overall depth of system

| THK mm | o.d.s. mm | $\alpha_p$ , Practical sound absorption coefficient |        |        |         |         |         | $\alpha_w$ | Sound absorption class |
|--------|-----------|---|--------|--------|---------|---------|---------|------------|------------------------|
|        |           | 125 Hz  | 250 Hz | 500 Hz | 1000 Hz | 2000 Hz | 4000 Hz |            |                        |
| 20     | 200       | 0.45  | 0.85   | 1.00   | 0.95    | 1.00    | 1.00    | 1.00       | A                      |
| 35     | 50        | 0.15  | 0.65   | 1.00   | 1.00    | 1.00    | 1.00    | 0.95       | A                      |
| 35     | 200       | 0.55  | 1.00   | 1.00   | 1.00    | 1.00    | 1.00    | 1.00       | A                      |

| THK mm | o.d.s. mm | NRC  | SAA  |
|--------|-----------|------|------|
| 35     | 50        | 0.95 |      |
| 35     | 200       | 1.05 |      |
| 35     | 400       | 0.90 | 0.92 |



## INDOOR AIR QUALITY

| Certificate / Label          |          |
|------------------------------|----------|
| Eurofins Indoor Air Comfort* | IAC Gold |
| French VOC                   | A+       |



## CARBON FOOTPRINT

Life-cycle stages A1 to C4 from EPD, in conformity with ISO 14025 / EN 15804

|                | kg CO <sub>2</sub> equiv/m <sup>2</sup> |
|----------------|---|
| Super G A 20mm | 3,28                                    |
| Super G A 35mm | 4,90                                    |



## CIRCULARITY

|  |                  |
|--|------------------|
| Minimum post-consumer recycled content (35 mm Super G A) | 51%              |
| Minimum post-consumer recycled content (20 mm Super G A) | 42%              |
| Recyclability  | Fully recyclable |



## FIRE SAFETY

The glass wool core of the tiles is tested and classified as non-combustible according to EN ISO 1182.

| Country |            | Class    |
|---------|------------|----------|
| Europe  | EN 13501-1 | A2-s1,d0 |



## HUMIDITY RESISTANCE

Class C, relative humidity 95% and 30°C, according to EN 13964:2014



## VISUAL APPEARANCE

White 085. Nearest NCS colour sample: S 1002-Y. Light reflectance: 78%.



## CLEANABILITY

Daily dusting and vacuum cleaning. Weekly wet wiping.



## ACCESSIBILITY

The tiles are not demountable.



## INSTALLATION

Installed according to installation diagrams, installation guides and drawing aid. (The tiles have to be installed according to the arrows on the back of the tile.)



## PACKAGING INFORMATION

Information is indicative and subject to change.

|             | Edge | Panels / crt | m <sup>2</sup> / crt |
|-------------|------|--------------|----------------------|
| 600x600x20  | A    | 28           | 10.08                |
| 1200x600x20 | A    | 14           | 10.28                |
| 600x600x35  | A    | 20           | 7.20                 |
| 1200x600x35 | A    | 10           | 7.20                 |
| 1600x600x35 | A    | 6            | 5.76                 |
| 1800x600x35 | A    | 6            | 6.48                 |
| 2000x600x35 | A    | 6            | 7.20                 |
| 2400x600x35 | A    | 6            | 8.64                 |



## SYSTEM WEIGHT

Weight information is indicative and subject to variation.

|                                       | kg/m <sup>2</sup> |
|---------------------------------------|-------------------|
| Super G A 20 mm                       | 1,7               |
| Super G A 20 mm + Connect Grid System | 2,7               |
| Super G A 35 mm                       | 2,6               |
| Super G A 35 mm + Connect Grid System | 3,6               |



## MECHANICAL PROPERTIES

See table regarding the min- and max- load bearing capacities and functional demands.



## IMPACT RESISTANCE

Tested and classified according to EN 13964 annex D.

| Thickness | M-sketch | Classification |
|-----------|----------|----------------|
| 20        | M199     | 3A             |
| 35        | M55      | 2A             |



## CE

Ecophon ceiling systems are CE marked according to the European harmonized standard EN13964:2014. CE marked construction products are covered by a Declaration of Performance (DOP) which enables customers and users to easily compare performance of products available on the European market.

## COLOURS AND DESIGN

### Super G



White 085

Suspended ceiling

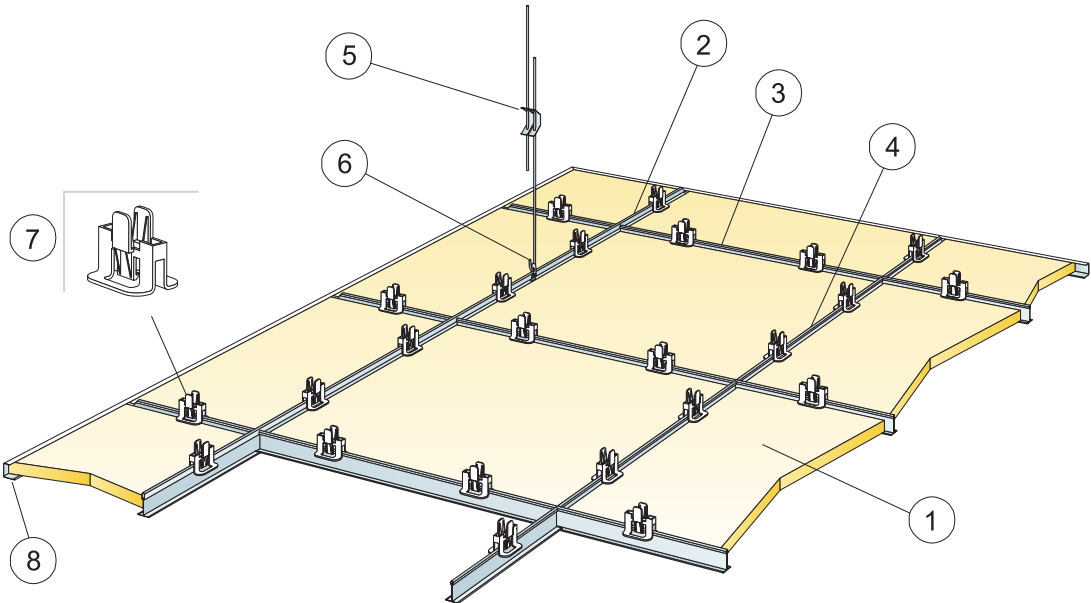

© Ecophon Group

Installation diagram (M199) for Ecophon Super G A (20mm)

Quantity specification (excl. wastage)

|  | Size, mm            |                     |
|--|---------------------|---------------------|
|  | 600x600             | 1200x600            |
| 1 Super G A  | 2,8/m <sup>2</sup>  | 1,4/m <sup>2</sup>  |
| 2 Connect T24 Main runner, installed at 1200 mm centres (max distance from wall 300 mm)    | 0,9m/m <sup>2</sup> | 0,9m/m <sup>2</sup> |
| 3 Connect T24 Cross tee, L=1200 mm, installed at 600 mm centres                            | 1,7m/m <sup>2</sup> | 1,7m/m <sup>2</sup> |
| 4 Connect T24 Cross tee, L=600 mm  | 0,9m/m <sup>2</sup> | -                   |
| 5 Connect Adjustable Hanger, installed at 1200 mm centres (max. distance from wall 600 mm) | 0,7/m <sup>2</sup>  | 0,7/m <sup>2</sup>  |
| 6 Connect Hanger clip (secured with screw)   | 0,7/m <sup>2</sup>  | 0,7/m <sup>2</sup>  |
| 7 Connect Hygiene Clip 20  | 11/m <sup>2</sup>   | 7/m <sup>2</sup>    |
| 8 Connect Channel Trim, fixed c300   | as required         | as required         |
| Δ Min. overall depth of system: 150 mm   |                     |                     |
| δ Min. demounting depth: 150 mm (non-clipped panel)  |                     |                     |

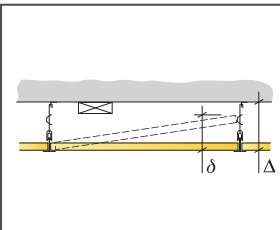

See Quantity Specification

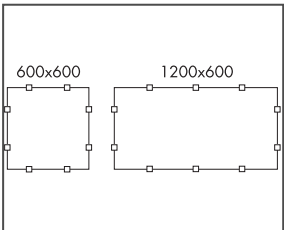

Arrangement of clips

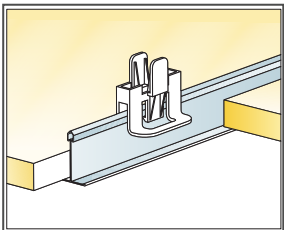

Clip for keeping tiles in place

| Size, mm    | Max live load (N) | Min load bearing capacity (N) |
|-------------|-------------------|-------------------------------|
| 600x600x20  | 50                | 160                           |
| 1200x600x20 | 50                | 160                           |

Live load/load bearing capacity

Suspended ceiling

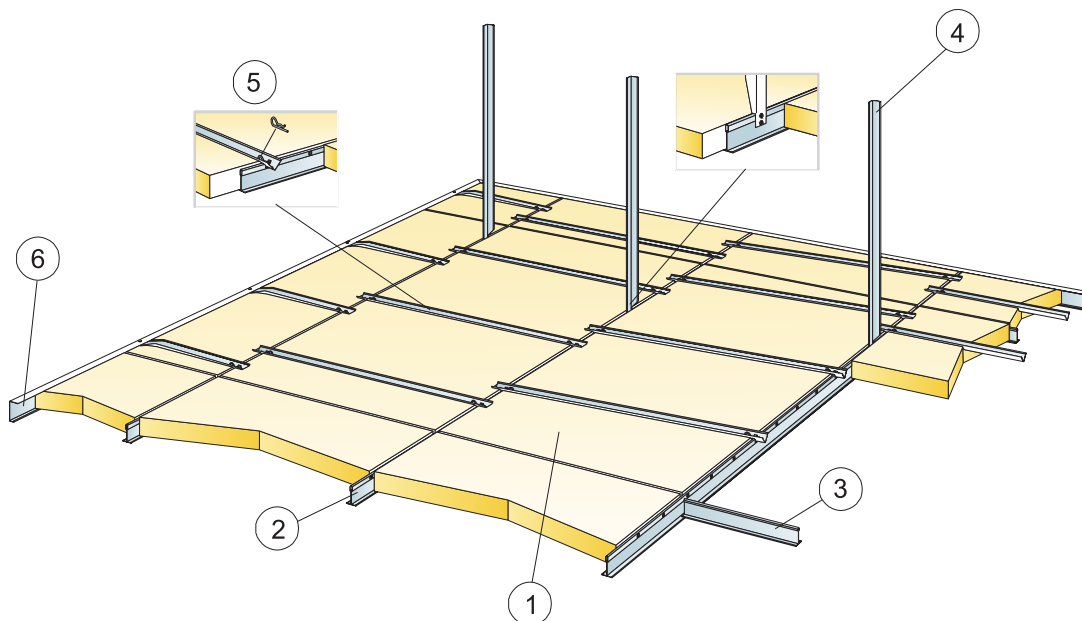

© Ecophon Group

Installation diagram (M55) for Ecophon Super G A and Super G A XL, suspended installation (35mm)

Quantity specification (excl. wastage)

|  | Size, mm            |                     |
|--|---------------------|---------------------|
|  | 600x600             | 1200x600            |
| 1 Super G A and Super G A XL   | 2,8/m <sup>2</sup>  | 1,4/m <sup>2</sup>  |
| 2 Connect T24 Main runner, installed at 600 mm centres                       | 1,7m/m <sup>2</sup> | 1,7m/m <sup>2</sup> |
| 3 Connect T24 Cross tee, L=600 mm  | 1,7m/m <sup>2</sup> | 0,9m/m <sup>2</sup> |
| 4 Rigid hanger made of Connect Angle trim, max. L=1200 mm at 1200 mm centres | 1,4/m <sup>2</sup>  | 1,4/m <sup>2</sup>  |
| 5 Connect Impact Bracing (Split pins included)                               | 5,6/m <sup>2</sup>  | 4,2/m <sup>2</sup>  |
| 6 Connect Channel trim, fixed at 300 mm centres (h=44 mm)                    | as required         | as required         |
| Δ Min. overall depth of system: 200 mm                                       |                     |                     |
| δ Min. demounting depth: 200 mm (for tile without Impact bracing)            |                     |                     |

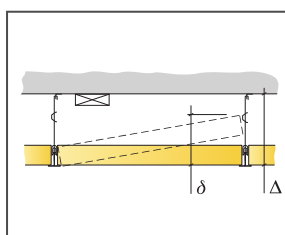

See Quantity Specification

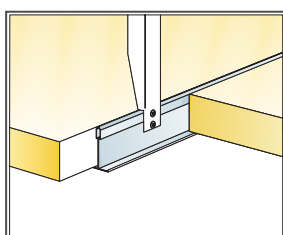

Detail of suspension

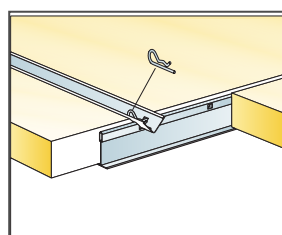

Connection between profiles with split pin

| Size, mm    | Max live load (N) | Min load bearing capacity (N) |
|-------------|-------------------|-------------------------------|
| 600x600x35  | 40                | 160                           |
| 1200x600x35 | 40                | 160                           |

Live load/load bearing capacity