

ECOPHON SOLO™ RECTANGLE

Solo Rectangle is a free hanging unit, offering high level design possibilities. Three different suspension systems offer opportunities to create several layers and angles. Suitable when the room volume should be maintained or when it's not possible to install a wall-to-wall ceiling.



Ecophon Solo™ Rectangle

SYSTEM RANGE

Size, mm	1200x600	1800x1200	2400x600	2400x1200	3000x1200
Special Fixing	•	•	•	•	•
Thickness (THK)	40	40	40	40	40
Inst. Diagr.	M637	M404, M506	M405	M406, M407, M506	M408

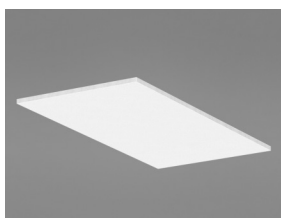

Solo Rectangle

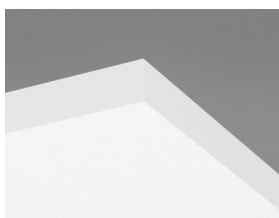

Solo panel



Suspension with Connect Adjustable wire hanger and Connect Absorber anchor



Suspension with Connect Absorber bracket and Connect Absorber anchor

TYPE OF APPLICATION

- Healthcare
- Office



ACOUSTICS

The values in the diagram refer to a single unit. If the units are arranged in a cluster with distances between units less than 0,5 meters, the Aeq per unit will be slightly reduced.

Sound Absorption

Test results according to EN ISO 354.

A_{eq}, Equivalent absorption area per unit (m² sabin)

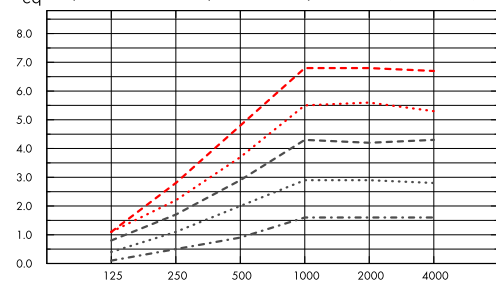

- Solo Rectangle 2400x1200, 1000 mm o.d.s.
 - Solo Rectangle 1800x1200, 1000 mm o.d.s.
 - Solo Rectangle 2400x600, 1000 mm o.d.s.
 - - - Solo Rectangle 3000x1200, 1000 mm o.d.s.
 - - - Solo Rectangle 1200x600, 1000 mm o.d.s.
- o.d.s = overall depth of system

	THK mm	o.d.s. mm	A _{eq} Equivalent absorption area per unit (m ² sabin)					
			125 Hz	250 Hz	500 Hz	1000 Hz	2000 Hz	4000 Hz
2400x1200	40	200	1.3	2.8	3.5	4.1	4.1	3.9
2400x1200	40	400	1.2	2.4	3.3	4.7	4.9	4.7
2400x1200	40	1000	1.1	2.2	3.7	5.5	5.6	5.3
1800x1200	40	200	0.6	2.0	2.9	3.4	3.3	3.1
1800x1200	40	400	0.8	1.9	2.6	3.7	3.7	3.6
1800x1200	40	1000	0.8	1.7	2.9	4.3	4.2	4.3
2400x600	40	200	0.5	1.4	2.0	2.4	2.3	2.3
2400x600	40	400	0.4	1.2	1.8	2.6	2.7	2.7
2400x600	40	1000	0.4	1.1	2.0	2.9	2.9	2.8
3000x1200	40	200	1.1	3.3	4.4	5.1	5.1	5.0
3000x1200	40	400	1.2	3.0	4.2	5.8	5.8	5.7
3000x1200	40	1000	1.1	2.8	4.8	6.8	6.8	6.7
1200x600	40	200	0.1	0.7	1.0	1.3	1.3	1.4
1200x600	40	400	0.2	0.5	0.9	1.4	1.5	1.6
1200x600	40	1000	0.1	0.5	0.9	1.6	1.6	1.6



INDOOR AIR QUALITY

Certificate / Label	Standard
French VOC	A+
Eurofins Indoor Air Comfort®	IAC



CARBON FOOTPRINT

Life-cycle stages A1 to C4 from EPD, in conformity with ISO 14025 / EN 15804

	kg CO ₂ equiv/m ²
Solo Rectangle	9,12



CIRCULARITY

Minimum post-consumer recycled content	53%
Recyclability	Fully recyclable



FIRE SAFETY

The glass wool core of the tiles is tested and classified as non-combustible according to EN ISO 1182.

Country	Fire standard	Class
Europe	EN 13501-1	A2-s1,d0



HUMIDITY RESISTANCE

Class C, relative humidity 95% and 30°C, according to EN 13964:2014



VISUAL APPEARANCE

White Frost, nearest NCS colour sample S 0500-N, 85% light reflectance. Gloss < 1.



CLEANABILITY

Daily dusting and vacuum cleaning. Weekly wet wiping.



ACCESSIBILITY

The tiles are demountable.



INSTALLATION

Installed according to installation diagrams, installation guides and drawing aid. For information regarding minimum overall depth of system see quantity specification.



SYSTEM WEIGHT

Weight information is indicative and subject to variation.

	kg/m ²
Solo Rectangle	3,5 - 4,7



MECHANICAL PROPERTIES

The tile can take both point loads and distributed loads. See Functional demands, Mechanical properties at www.ecophon.com.



CE

Ecophon ceiling systems are CE marked according to the European harmonized standard EN13964:2014. CE marked construction products are covered by a Declaration of Performance (DOP) which enables customers and users to easily compare performance of products available on the European market.

COLOURS AND DESIGN

Akutex™ FT

White Frost	Moonlight sky	Highland fog	Sunset heat	Ocean storm	Morning drizzle	Peach rose
Goji berry	Scallop shells	Fresh clover	Sage garden	Eucalyptus leaf	Summer forest	Golden field
Ruby rock	Wet sand	Silent steam	Dark diamond	Cloudy day	Volcanic ash	Silver stone
Silk slate						

Wire, Direct

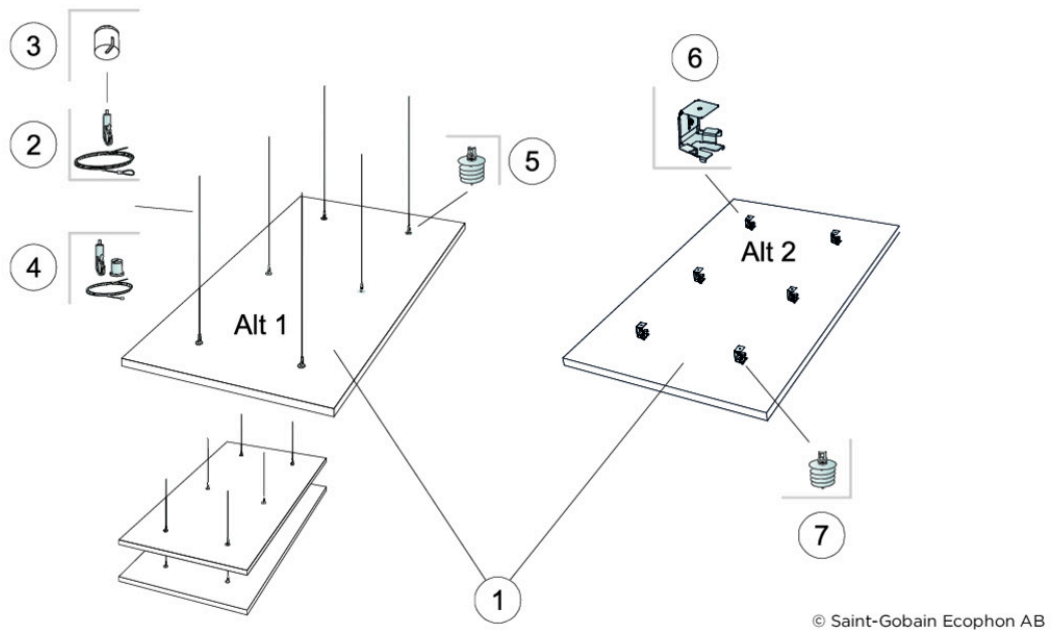

Installation diagram (M404) for Ecophon Solo Rectangle 1800x1200

Quantity specification (excl. wastage)

		Size, mm
		1800x1200
1	Solo Rectangle	2,16m ² /panel
Mounting Option 1		
2	Connect Looped Wire Hanger (Hook + Looped wire)	6/panel
3	Connect Covering cup (Optional)	6/panel
4	Connect Wire Kit (Hook + Ceiling holder + Wire)	6/panel
5	Connect Absorber anchor	6/panel
Mounting Option 2		
6	Connect Absorber bracket	6/panel
7	Connect Absorber anchor	6/panel
Notes		
Δ Min. overall depth of system: Δ1 140 mm / Δ2 90 mm		-

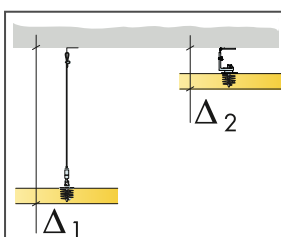

See Quantity specification

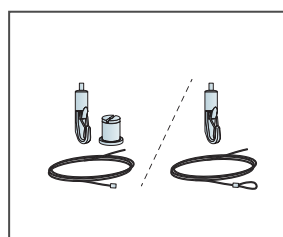

Two types of Adjustable wire solutions

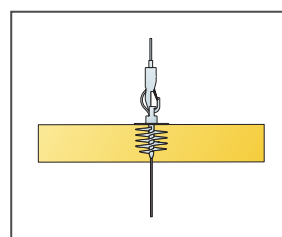

Panels can be suspended underneath each other

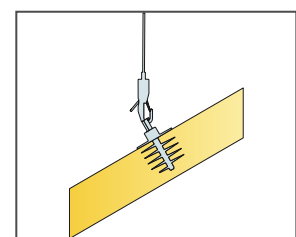

Panels can be installed in angles

Wire, Direct

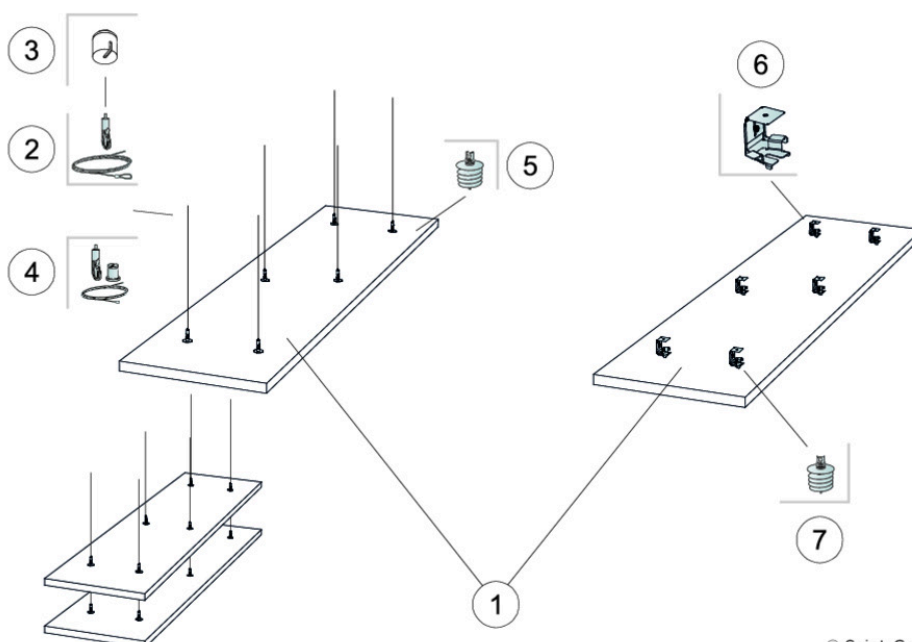

© Saint-Gobain Ecophon AB

Installation diagram (M405) for Ecophon Solo Rectangle 2400x600

Quantity specification (excl. wastage)

		Size, mm
		2400x600
1	Solo Rectangle	1,44m ² /panel
Mounting Option 1		
2	Connect Looped Wire Hanger (Hook + Looped wire)	6/panel
3	Connect Covering cup (Optional)	6/panel
4	Connect Wire Kit (Hook + Ceiling holder + Wire)	6/panel
5	Connect Absorber anchor	6/panel
Mounting Option 2		
6	Connect Absorber bracket	6/panel
7	Connect Absorber anchor	6/panel
Notes		
Δ Min. overall depth of system: Δ1 140 mm / Δ2 90 mm		

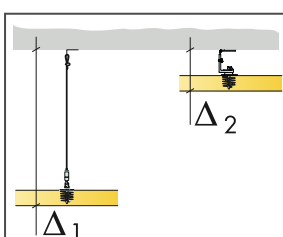

See Quantity specification

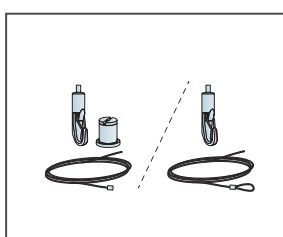

Two types of Adjustable wire solutions

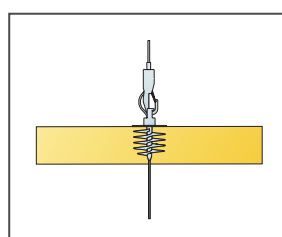

Panels can be suspended underneath each other

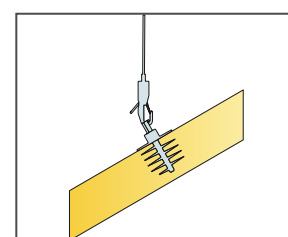

Panels can be installed in angles

Wire, Wire+Load Spreader

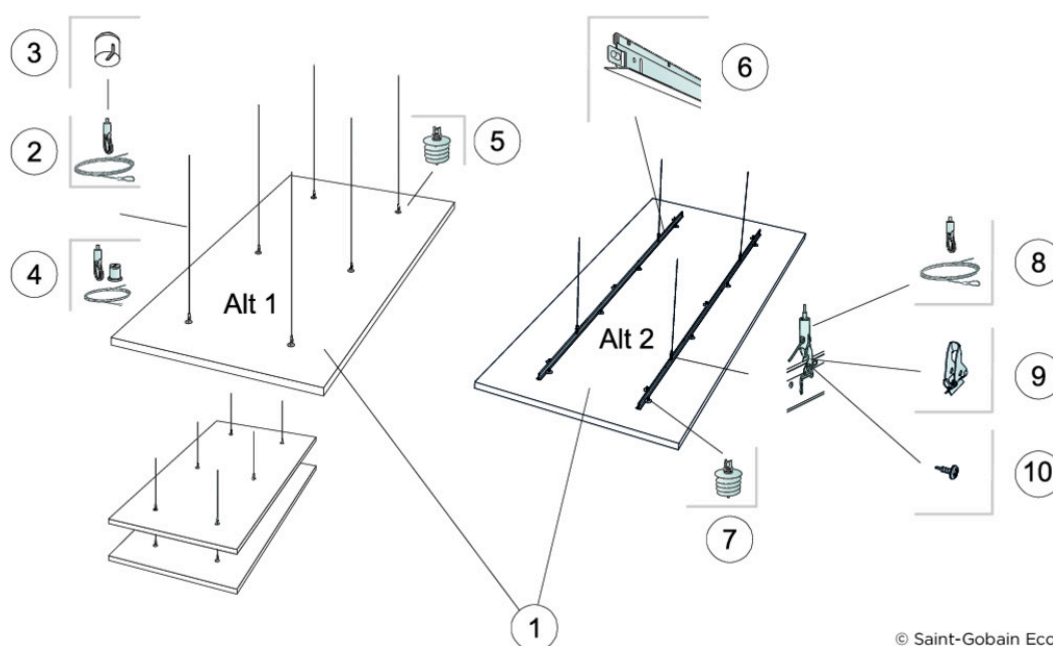

© Saint-Gobain Ecophon AB

Installation diagram (M406) for Ecophon Solo Rectangle 2400x1200

Quantity specification (excl. wastage)

		Size, mm
		2400x1200
1	Solo Rectangle	2,88m ² /panel
Mounting Option 1		
2	Connect Looped Wire Hanger (Hook + Looped wire)	6/panel
3	Connect Covering cup (Optional)	6/panel
4	Connect Wire Kit (Hook + Ceiling holder + Wire)	6/panel
5	Connect Absorber anchor	6/panel
Mounting Option 2		
6	Connect T24 Main runner	2/panel
7	Connect Absorber anchor	14/panel
8	Connect Looped Wire Hanger (Hook + Looped wire)	4/panel
9	Connect Hanger Clip	4/panel
10	Connect Installation screw BR	4/panel
Notes		
Δ Min. overall depth of system: Δ1 140 mm / Δ2 200 mm		-

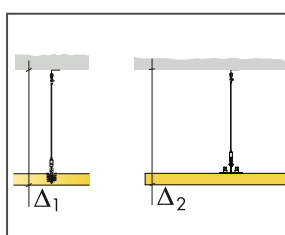

See Quantity specification

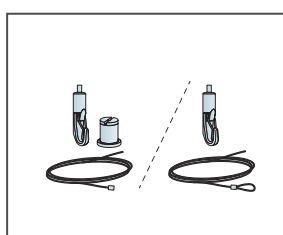

Two types of Adjustable wire solutions

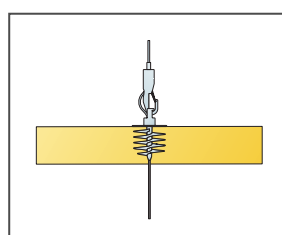

Panels can be suspended underneath each other

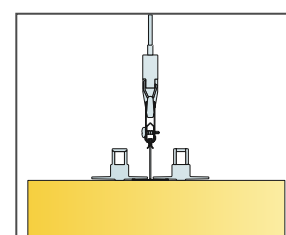

Installation with T24 Main runner

Wire One Point, Direct

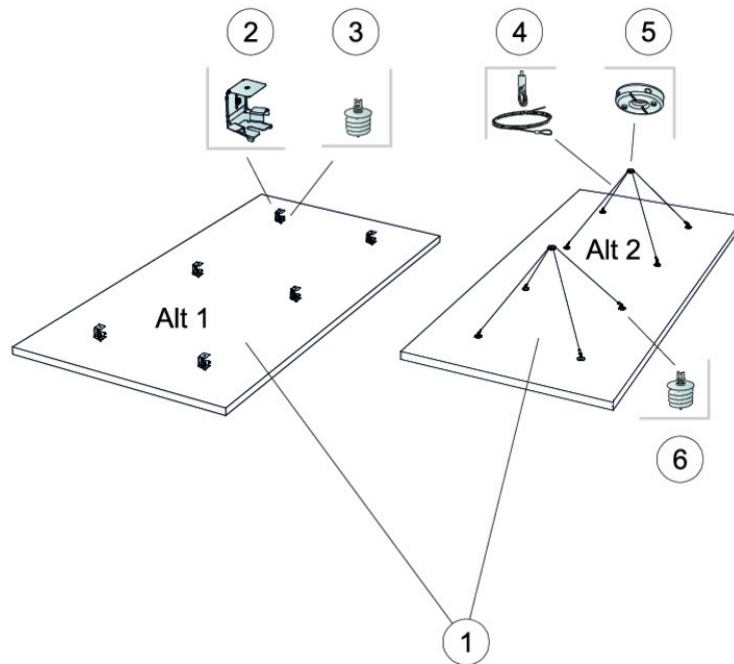

© Saint-Gobain Ecophon AB

Installation diagram (M407) for Ecophon Solo Rectangle 2400x1200

Quantity specification (excl. wastage)

		Size, mm
		2400x1200
1	Solo Rectangle	2,88m ² /panel
Mounting Option 1		-
2	Connect Absorber bracket	6/panel
3	Connect Absorber anchor	6/panel
Mounting Option 2		-
4	Connect Looped Wire Hanger (Hook + Looped wire)	4/panel
5	Connect One-point fixing	2/panel
6	Connect Absorber anchor	8/panel
Notes		-
Δ Min. overall depth of system: Δ1 90 mm / Δ2 500 mm		

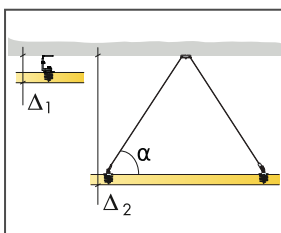

See Quantity specification

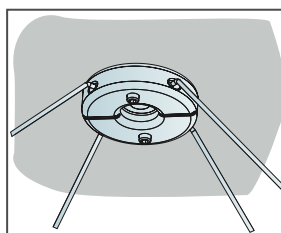

Detail of One-point fixing

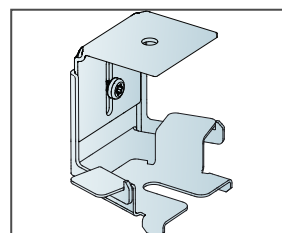

Details of Absorber bracket.
Overall depth of system between 90-130mm

Wire, Wire+Load Spreader

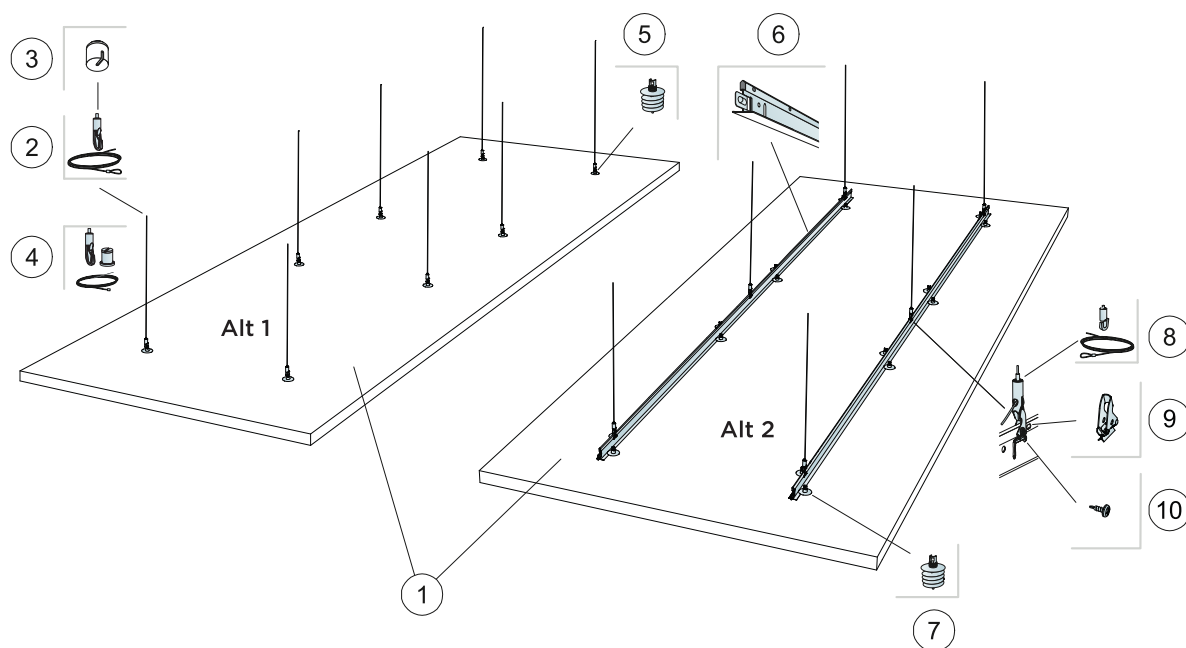

© Saint-Gobain Ecophon AB

Installation diagram (M408) for Ecophon Solo Rectangle 3000x1200

Quantity specification (excl. wastage)

		Size, mm
		3000x1200
1	Solo Rectangle	3,6m ² /panel
Mounting Option 1		-
2	Connect Looped Wire Hanger (Hook + Looped wire)	8/panel
3	Connect Covering cup (Optional)	8/panel
4	Connect Wire Kit (Hook + Ceiling holder + Wire)	8/panel
5	Connect Absorber anchor	8/panel
Mounting Option 2		-
6	Connect T24 Main runner	2/panel
7	Connect Absorber anchor	16/panel
8	Connect Looped Wire Hanger (Hook + Looped wire)	6/panel
9	Connect Hanger Clip	6/panel
10	Connect Installation screw BR	6/panel
Δ Min. overall depth of system: Δ1 140 mm / Δ2 200 mm		

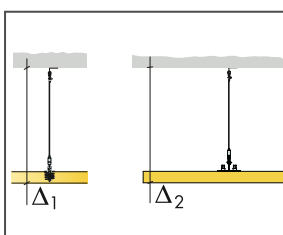

See Quantity specification

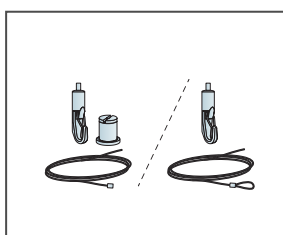

Two types of Adjustable wire solutions

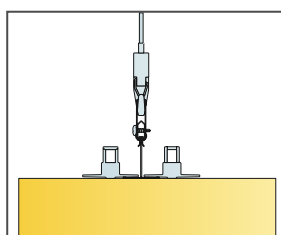

Installation with T24 Main runner

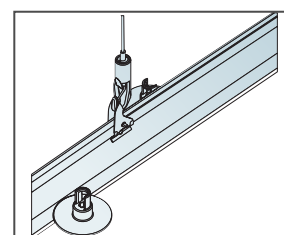

Installation of hanger clips

Wire (Solo Rectangle kit)

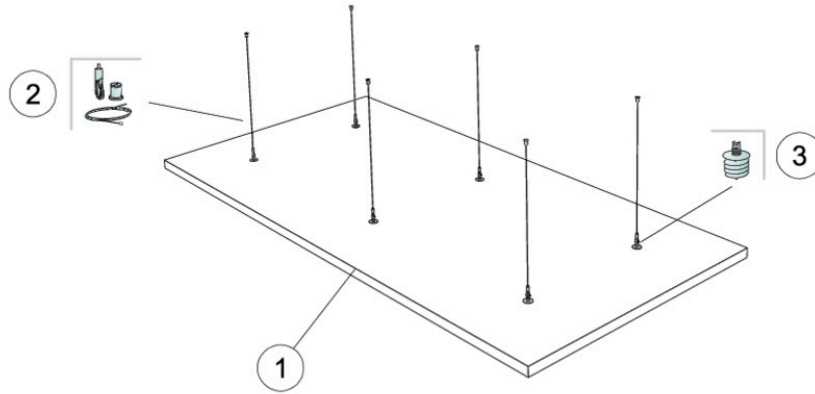

© Saint-Gobain Ecophon AB

Installation diagram (M506) for Ecophon Solo Rectangle Kit 1800/2400x1200

Quantity specification (excl. wastage)

	Size, mm	
	1800x1200	2400x1200
1 Solo Rectangle Kit	2,16m ² /panel	2,88m ² /panel
2 Connect Adjustable wire kit 1500mm (included)	-	-
3 Connect Absorber anchor (included)	-	-
Δ Min. overall depth of system: Δ 140 mm		
To install Connect Absorber Anchor, use Connect Absorber Anchor Bit.		

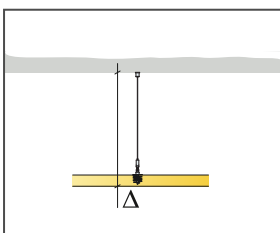

See Quantity specification

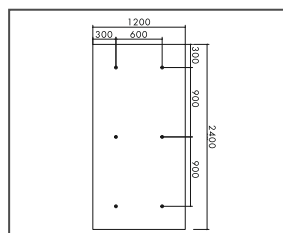

Suspension with absorber anchor, format 2400 x 1200

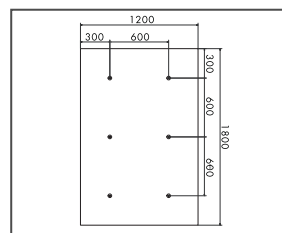

Suspension with absorber anchor, format 1800 x 1200

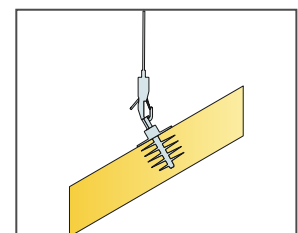

Panels can be installed in angles

Wire

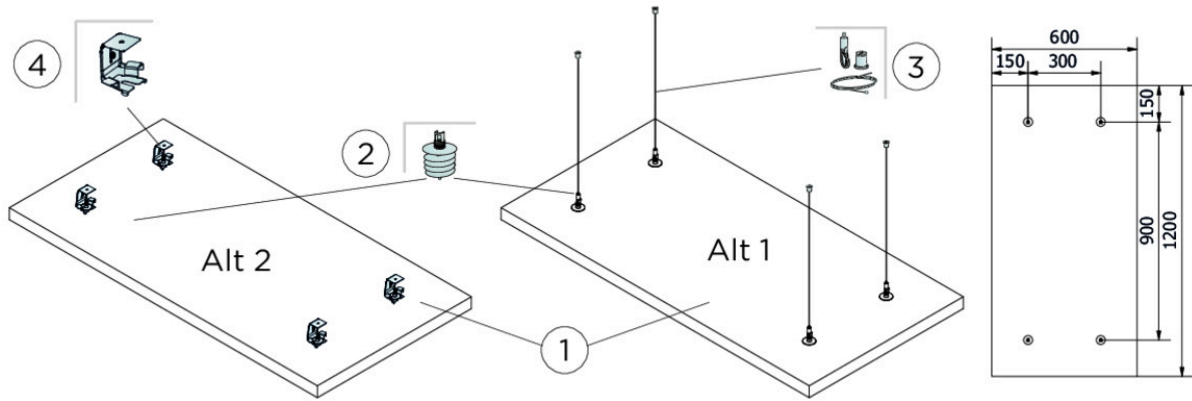

© Saint-Gobain Ecophon AB

Installation diagram (M637) for Ecophon Solo Rectangle 1200x600

Quantity specification (excl. wastage)

		Size, mm
		1200x600
1	Solo Rectangle	0,72m ² /panel
2	Connect Absorber anchor	4/panel
Mounting Option 1		-
3	Connect Wire Kit (Hook + Ceiling holder + Wire)	4/panel
Mounting Option 2		-
4	Connect Absorber bracket	4/panel
Notes		-
Δ Min. overall depth of system: Δ 140 mm		
To install Connect Absorber Anchor, use Connect Absorber Anchor Bit.		

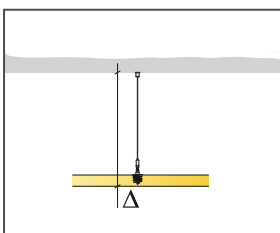

See Quantity specification

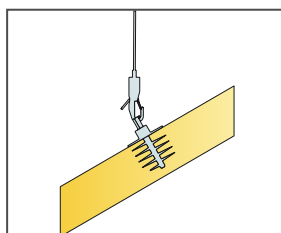

Panels can be installed in angles

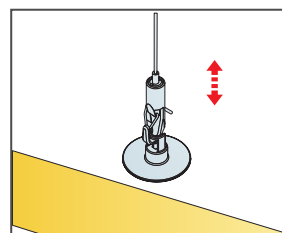

Easily adjustable suspension with Connect Adjustable wire hanger